

Machine room plane layout

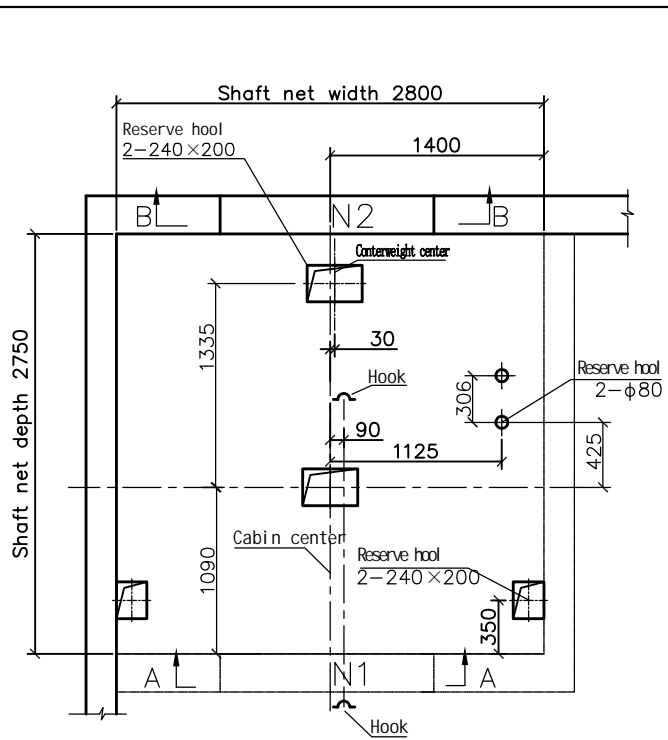

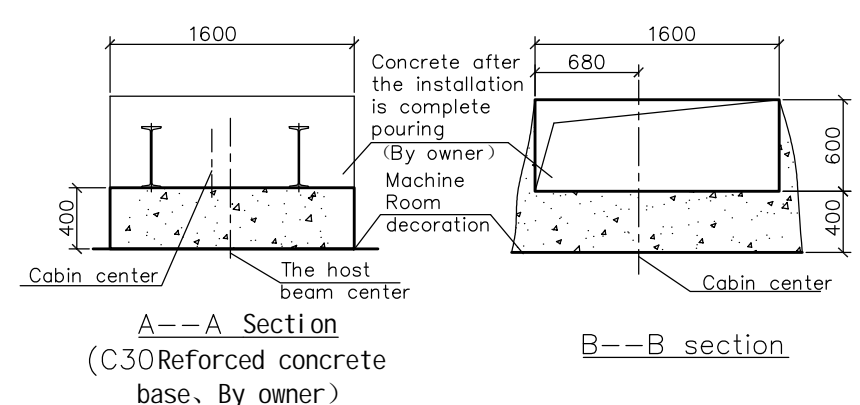

Machine room reserved hook plane drawing

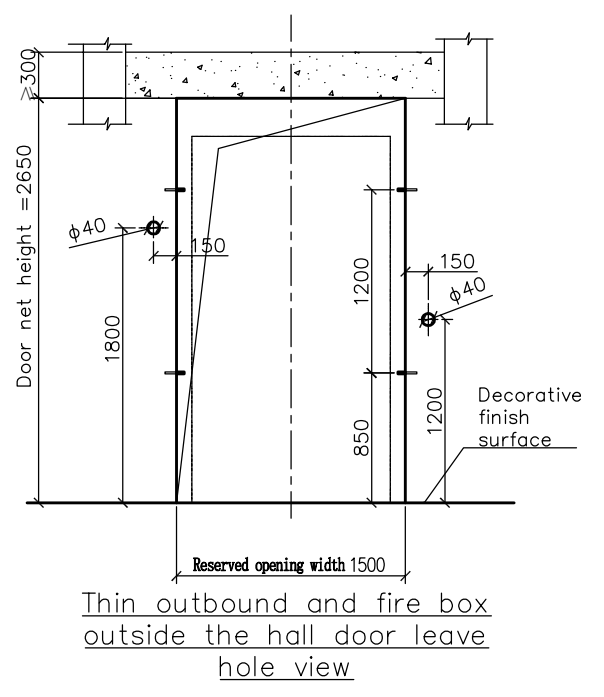
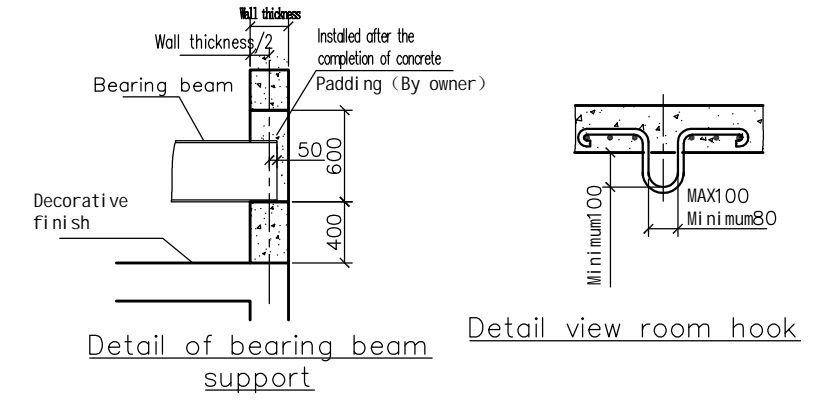

SIZE(m)	
TH	
TR	
PIT	6.8
100F(OH)	8.2
99F	
98F	
97F	
96F	
95F	
7F	
6F	
5F	
4F	
3F	
2F	
1F	
GF	
Pro	No.(m)

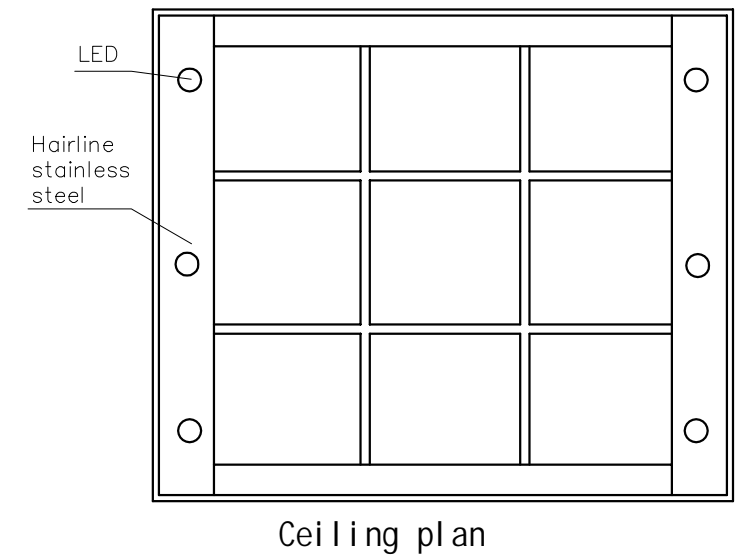
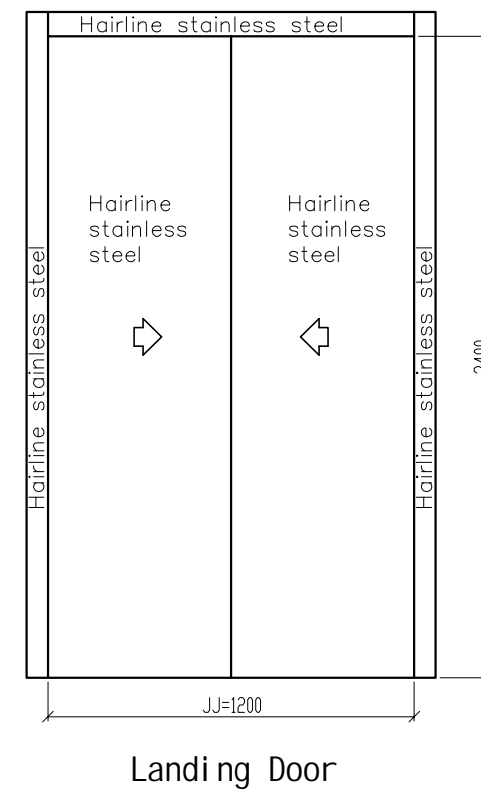
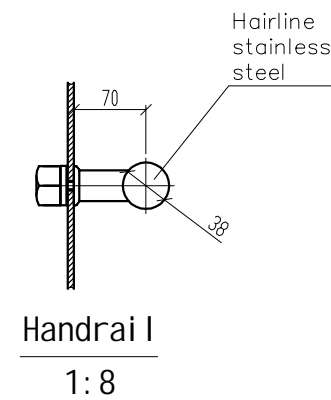
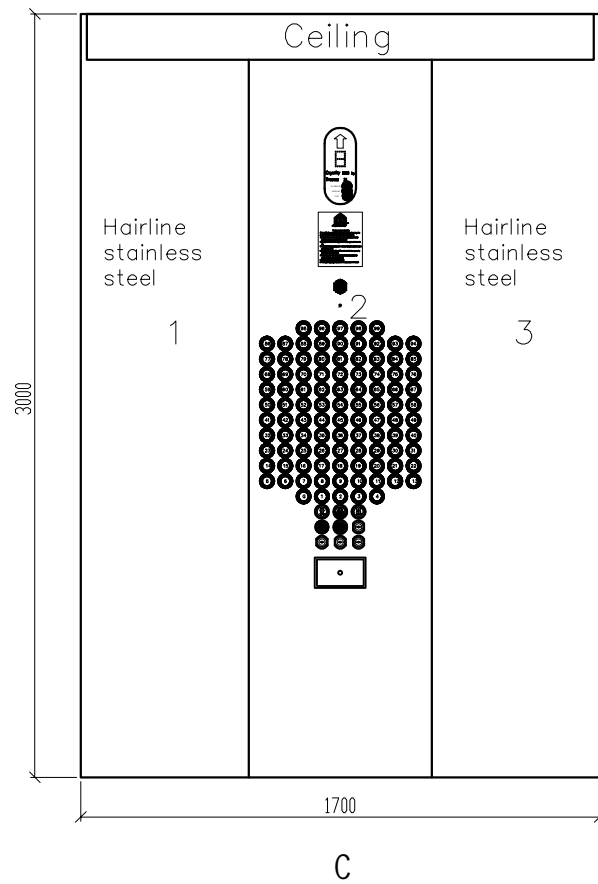
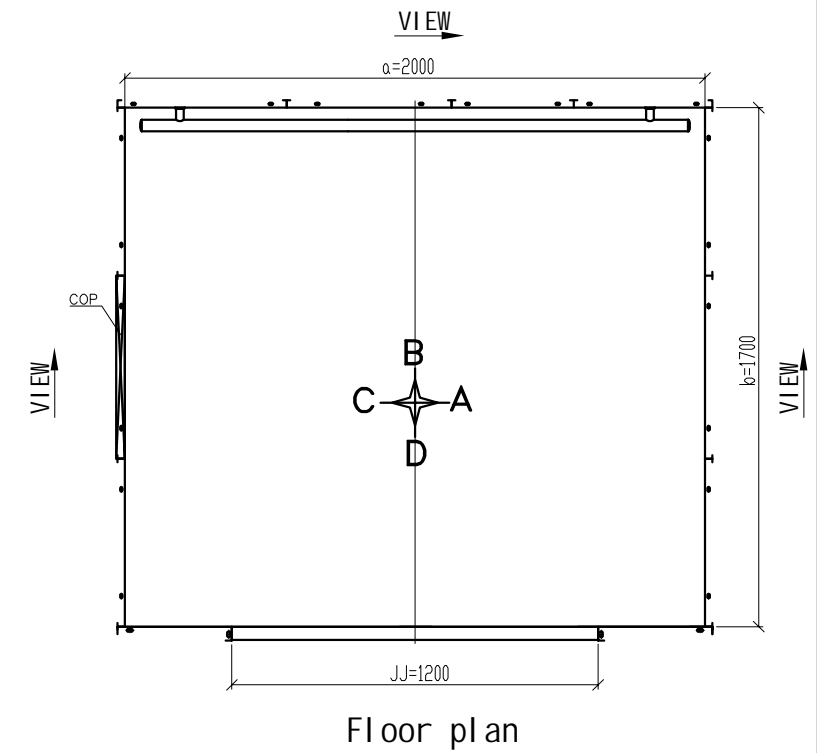
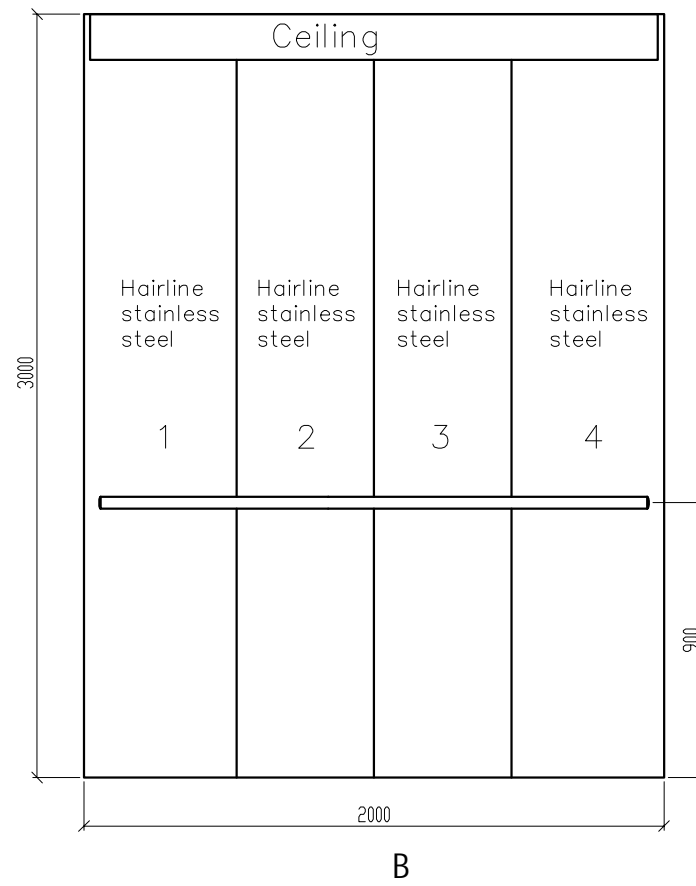
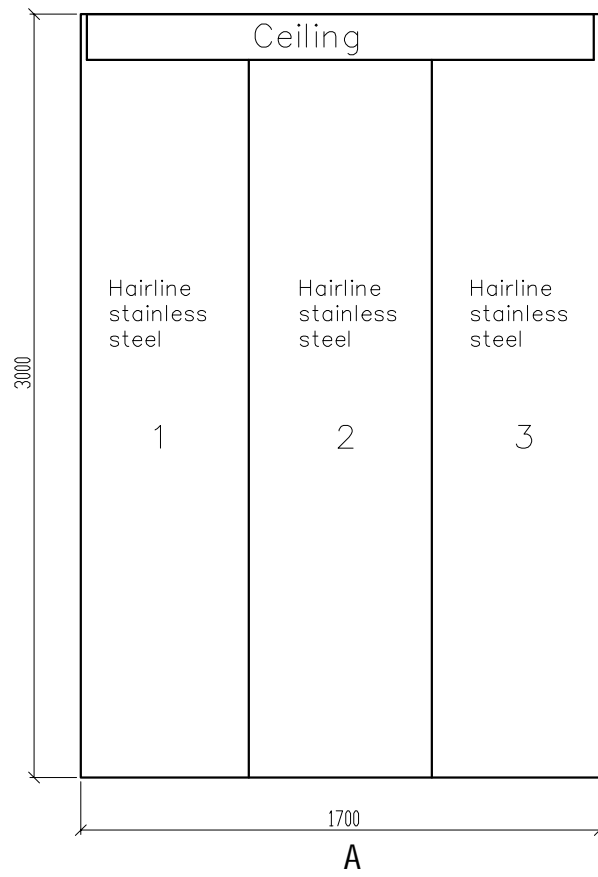
Equipment Specification		
Elevator Type	Passenger Lift	
Rated Load	1600kg	
Rated Speed	6.0m/s	
Control Style	Simplex	
Floor/Stop/Door	100/100/100	
Door Open Type	2-panel center	
Door Dimension (W*H) (mm)	1200*2400	
Car Dimension (W*D*H) (mm)	2000*1700*3000	
Suspension	2:1	
Shaft Dimension (W*D) (mm)	2800*2750	
Travel Height (TH)		
Pit Depth (PIT)	6800mm	
Shaft Head Height (OH)	8200mm	
Motor	Gearless	
HP (KW)	69.7kW	
Rope		
Rope Length (m)		
Rail	T127(Car)/T127(C.W.T)	
Rail Height (m)		
Quantity of guide rail brackets		
Buffer		
Safety gear	Progressive	
Hall dimension of the upper side of the shaft	1500*2650	
Car weight	1850kg	
Weight of counterweight	2700kg	
Control panel	VWF/Full Collective	
Traction Machine	Outputs 69.7KW	
	Rated Current	
Power Supply	For Power A.C 3-415V 50HZ	
	For light A.C 1-240V 50HZ	
	Capacity(for power) 7.5KVA	
	Capacity(for light) 3.3KVA	
Force(KN)	P1 (Car) 650	
	P2 (C.W.T.) 650	
	N1 230	
	N2 325	
Project:		
Contract No.:		
Type: SLP1600-6.0-C0	Sheet 1 of 3 sheets	
Designed by: Eva	Name: Date: Edition:	
Checked by: Tony	A	Drawg No.:
Approved by: Joe		DS-20161108-05
Title		
AUSTAND SLP Series		



 Austand Elevator				
Project:				
Contract No.:				
Type: SLP1600-6.0-C0				Sheet 2 of 3 sheets
Designed by:	Eva	Date:	Edition:	Drawg No. : DS-20161108-05
Checked by:	Tony		A	
Approved by:	Joe			
Title: AUSTAND SLP Series				

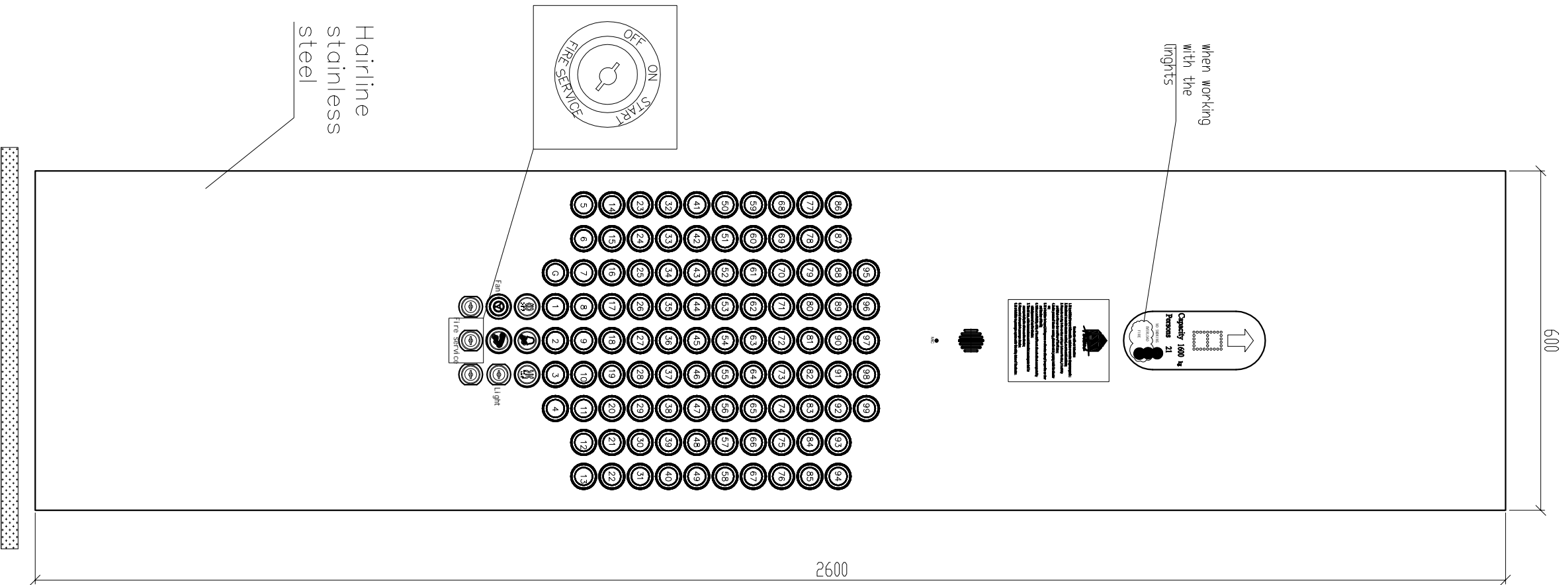

COP
4:1

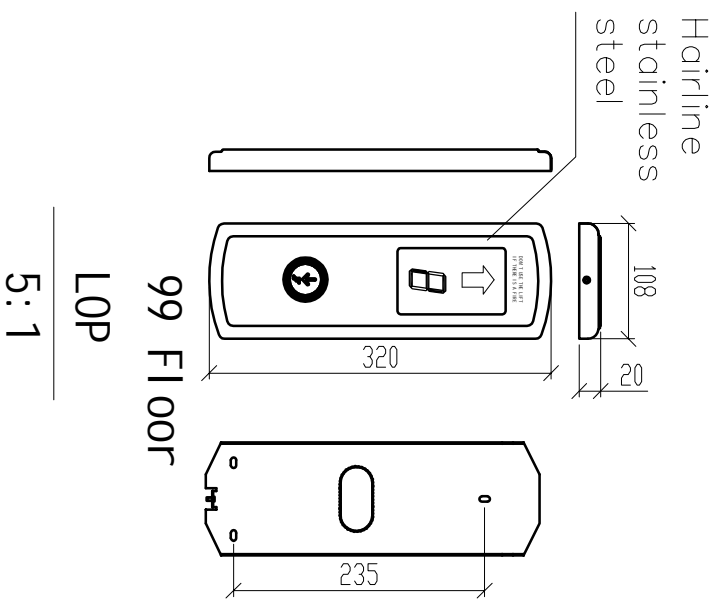
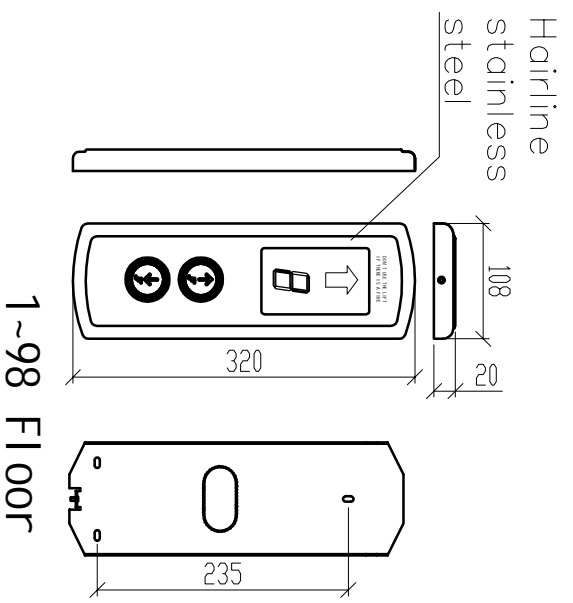
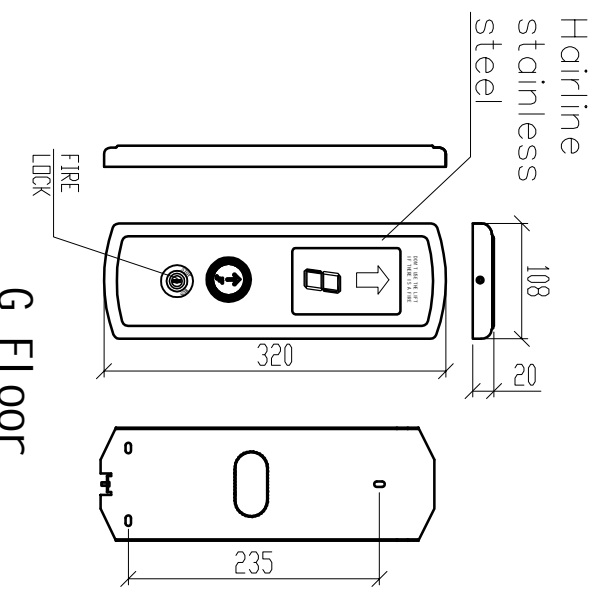

Austand Elevator

Project:

Contract No. :

Type: SLP1600-6.0-C0

Sheet 3 of 3 sheets

Name: Date: Edition:

Designed by:

Eva

Date:

Edition:

Drawng No. :

Checked by:

Tony

Date:

A

DS-20161108-06

Approved by:

Joe

Title: AUSTAND SLP Series