

Machine room plane layout drawing

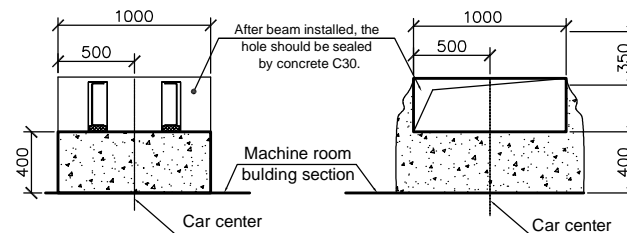

A--A Rotation

B--B Rotation

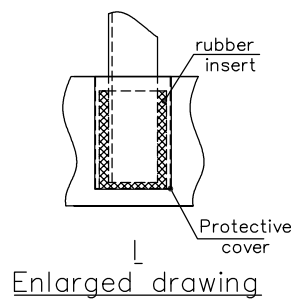
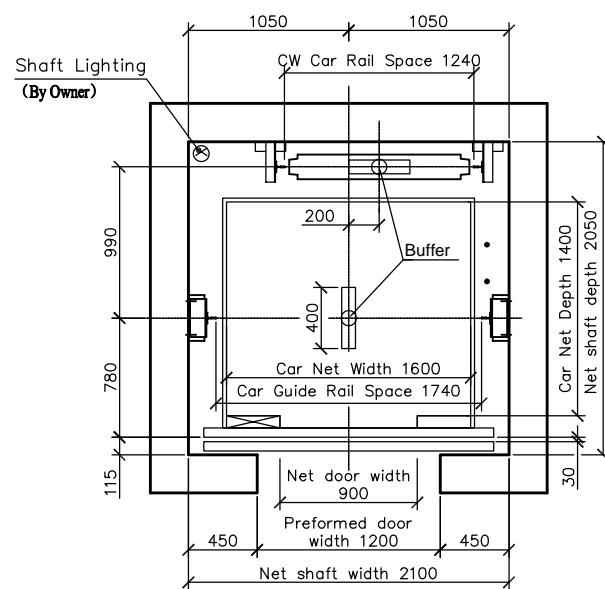

Shaft plane layout diagram

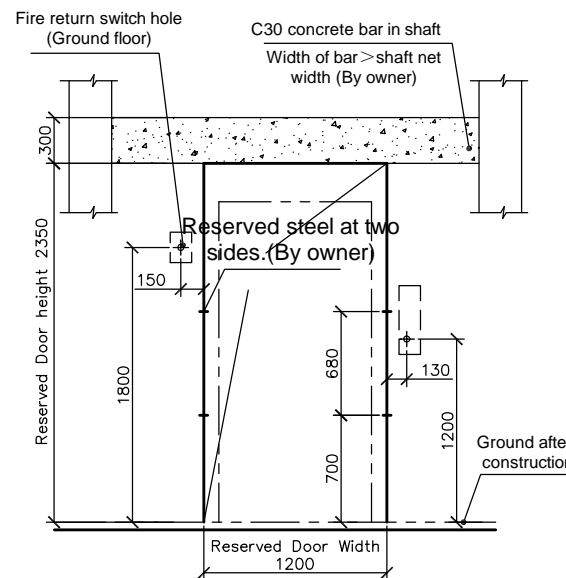

Landing door preformed hole

At the position of shaft where people can reach, the maximum load should be designed as 5000N at the bottom of shaft. And solid peg should be placed under the counterweight bumper extending to the firm ground.

Shaft and machine room elevation drawing

C30 steel concrete base (For installation of buffer, 4 PCS of φ12 steel bar are reserved here which should be out of pit ground 300 at least. Those bars should be at the circle of φ300). (Supported by owner)

SIZE(m)	
TH	
TR	
PIT	1.55
14F(OH)	4.25
13F	
12F	
11F	
10F	
9F	
8F	
7F	
6F	
5F	
4F	
3F	
2F	
1F	
GF	
Pro	No.(m)

Equipment Specification

Elevator Type	Passenger Lift	
Rated Load	1000kg	
Rated Speed	1.75m/s	
Control Style	Simplex	
Floor/Stop/Door	15/15/15	
Door Open Type	2-panel center	
Door Dimension (W*H) (mm)	900*2100	
Car Dimension (W*D*H) (mm)	1600*1400*2500	
Suspension	2:1	
Shaft Dimension (W*D) (mm)	2100*2050	
Travel Height (TH)		
Pit Depth (PIT)	1550mm	
Shaft Head Height (OH)	4250mm	
Motor	Gearless	
HP (KW)	12.0kW	
Rope	7*φ8(Pitch 12)	
Rope Length (m)		
Rail	T75(Car)/T75(C.W.T)	
Rail Height (m)		
Quantity of guide rail brackets		
Buffer	HYF175A(Car)/HYF175A(C.W.T)	
Safety gear	Progressive	
Hall dimension of the upper side of the shaft	1200*2350	
Car weight	1300kg	
Weight of counterweight	1850kg	
Control panel	VWF/Full Collective	
Traction Machine	Outputs	12.0KW
	Rated Current	28.2A
Power Supply	For Power	A.C 3-415V 50HZ
	For light	A.C 1-240V 50HZ
	Capacity(for power)	7.5KVA
	Capacity(for light)	3.3KVA
Force(KN)	P1 (Car)	101
	P2 (C.W.T.)	81
	N1	52
	N2	85



AUSTAND Elevator

Project:

Contract No.:

Type: SLP1000-1.75-C0

Sheet 1 of 3 sheets

Name:	Date:	Edition:
Designed by: Eva		
Checked by: Tony		A
Approved by: Joe		

Drawg No. : DS-20161108-02

Title AUSTAND SLP Series

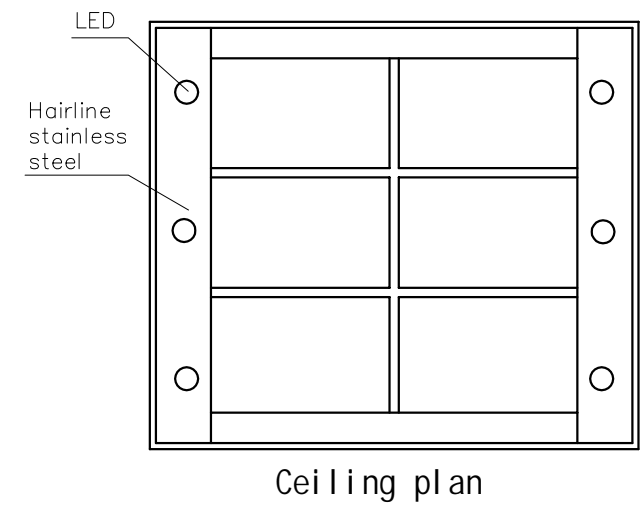
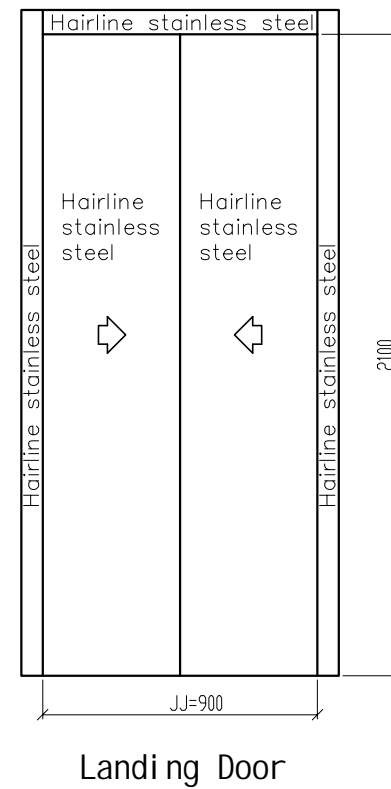
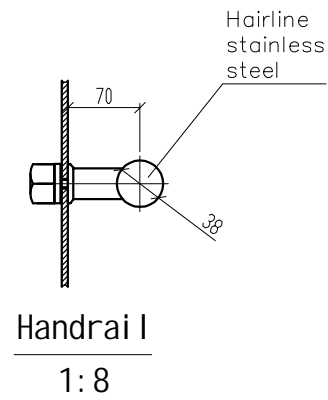
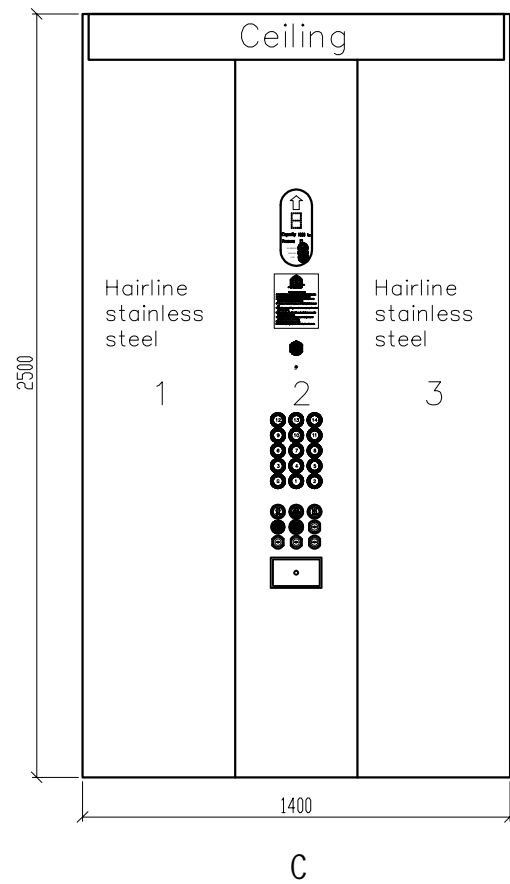
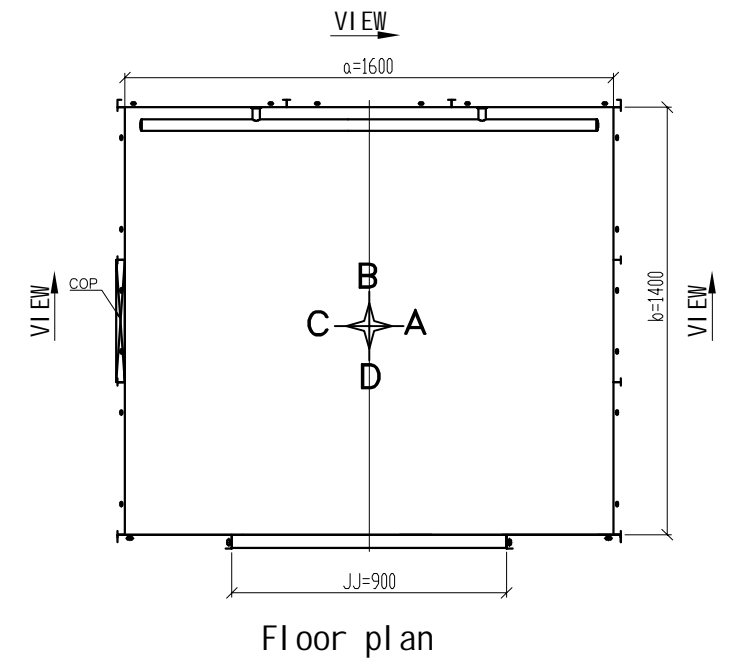
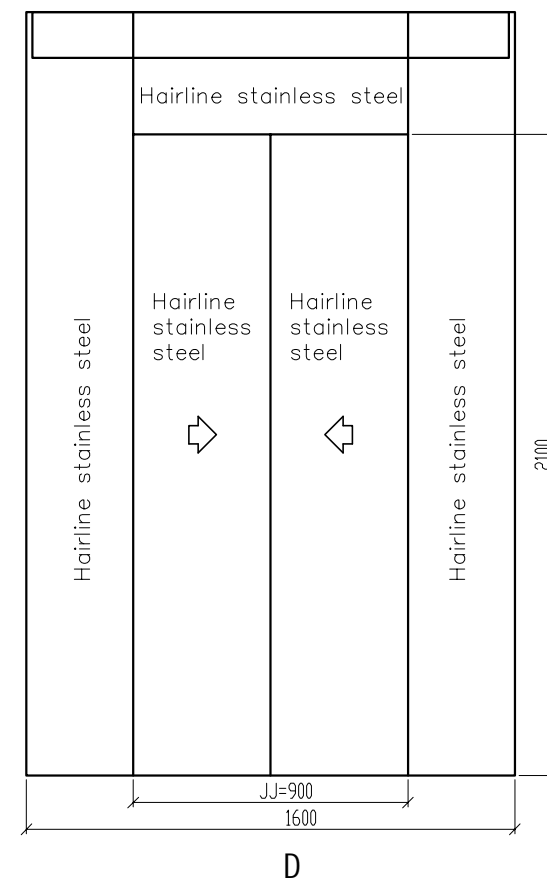
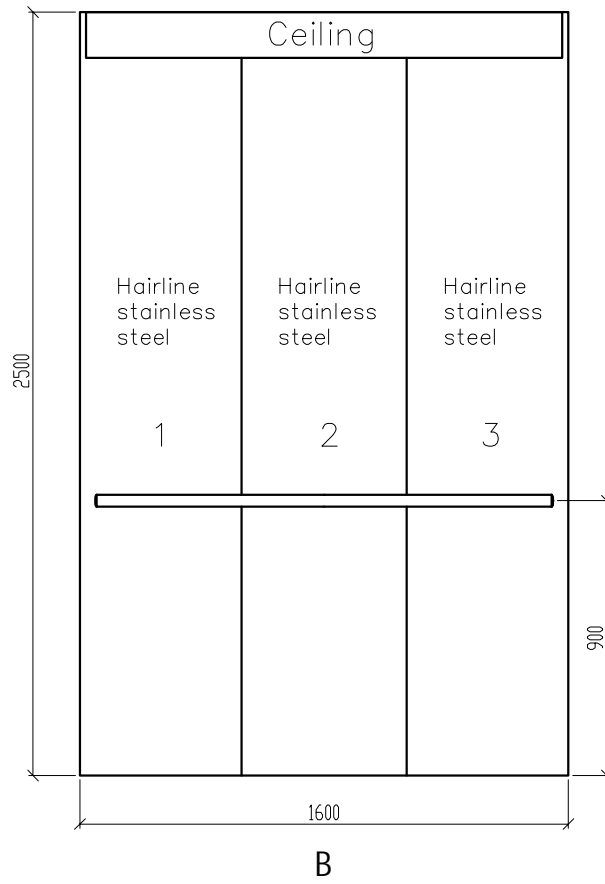
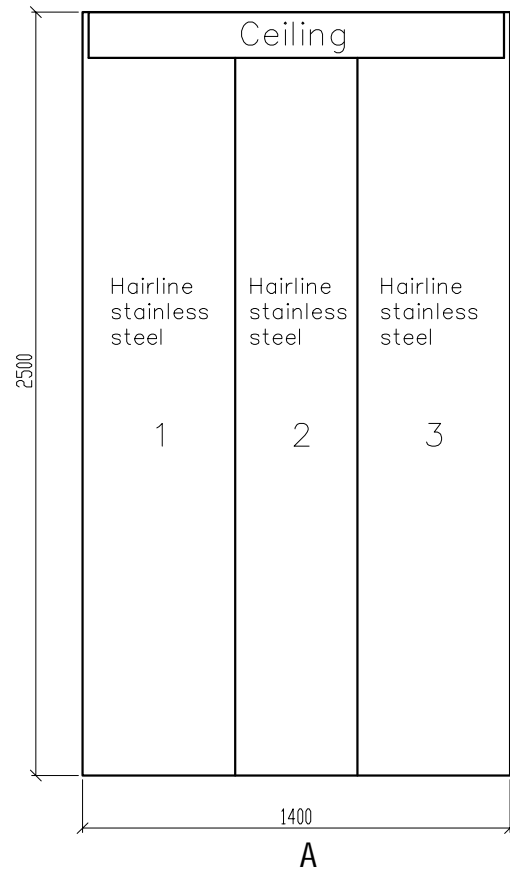

		<b>Austand Elevator</b>	
Project:			
Contract No.:			
Type: SLP1000-1.75-C0		Sheet 2 of 3 sheets	
Designed by:	Name: Eva	Date:	Edition: A
Checked by:	Tony	Drawg No. : DS-20161108-02	
Approved by:	Joe		
Title: <b>AUSTAND SLP Series</b>			

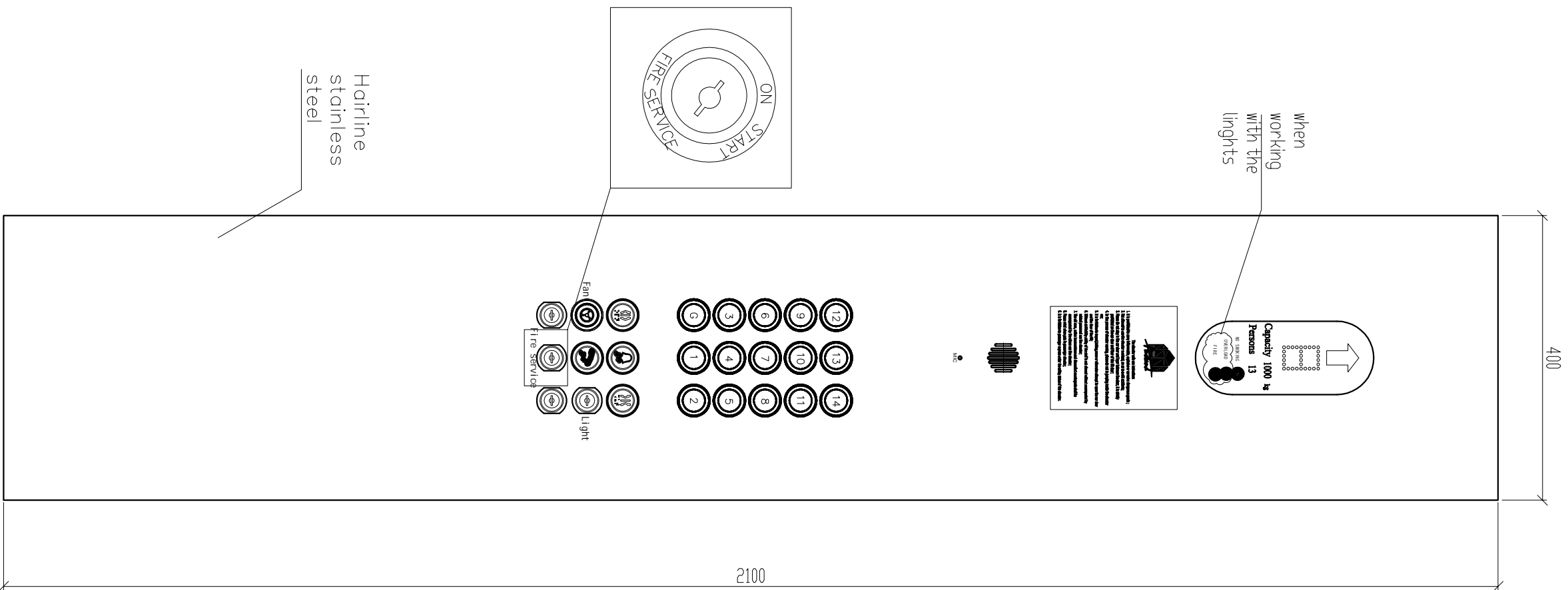

COP  
5:1

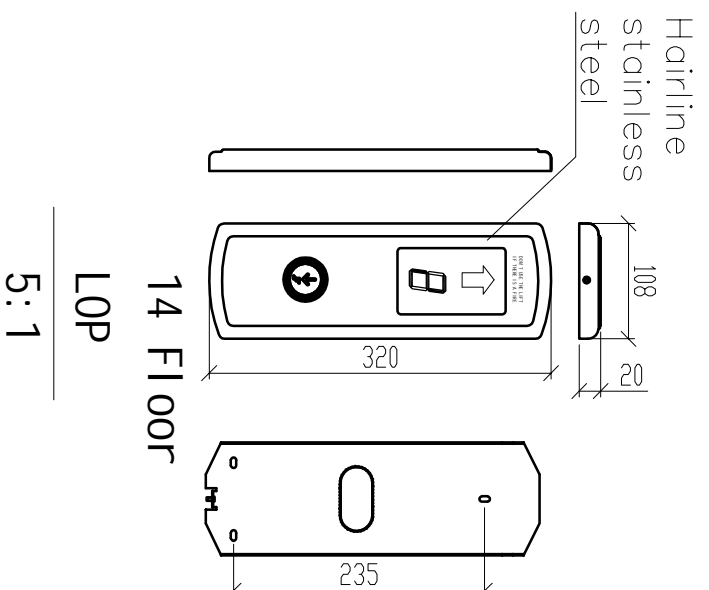
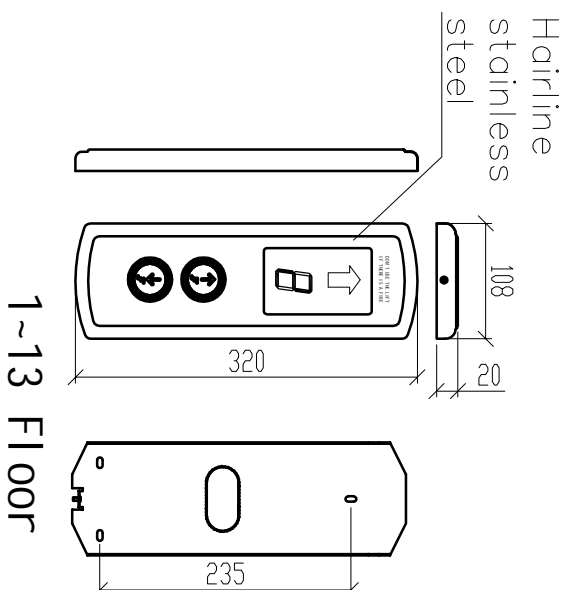
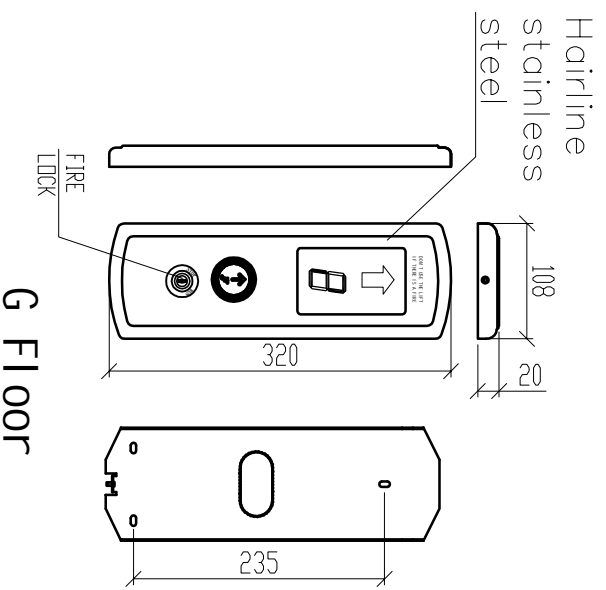

Austand Elevator

Project:

Contract No. :

Type: SLP1000-1.75-C0

Sheet 3 of 3 sheets

Name: Date: Edition:

Designed by: Eva

Date:

Edition:

Drawng No. :

Checked by: Tony

Date:

Edition:

A

DS-20161108-02

Approved by: Joe

Date:

Edition:

Title: AUSTAND SLP Series