

Detail A

Detail B

Detail C

Finished floor level (by user)

Embedded steel plate (by user)
30×170×1600

Screw thread steel 20×150 6pcs (by user)

Supply the wire of the power and lighting at the up area
The wire is 5×10mm (by user)

Customer physical

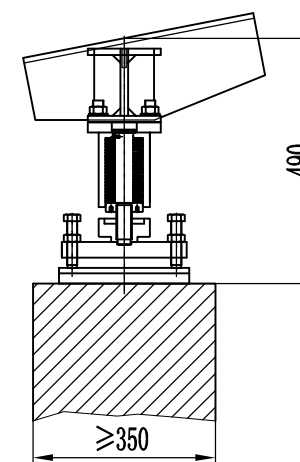
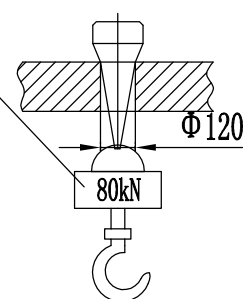

Specification parameter

Type	DSE-S	
Speed (m/s)	0.5m/s	
Rise	H = 3000 mm	
Angle	12°	
Supporting R1 (kN)	80 kN	
Supporting R2 (kN)	69 kN	
Supporting R3 (kN)	171 kN	
power	Power Supply	Three-phase AC 415V 50HZ
	Lighting Supply	Single-phase AC 240V 50HZ
contract number	Item name	

Approving construction based the request of the layoutdrawing

sealed by buyer

signed by buyer

Date

contract number

Designed by

Auditing by

Eva

Tony



AUSTAND Elevator