

Detail A

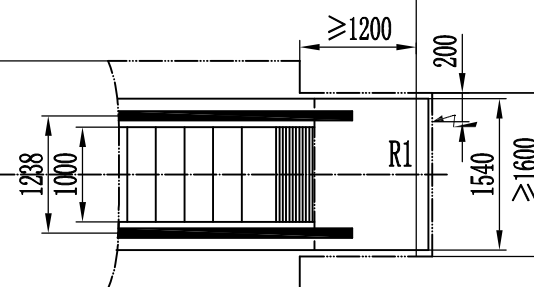

Detail B

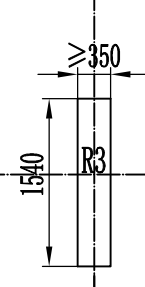
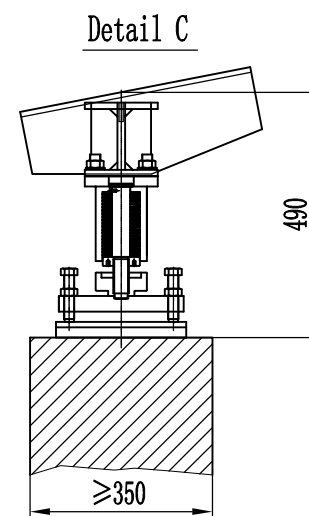

Detail C

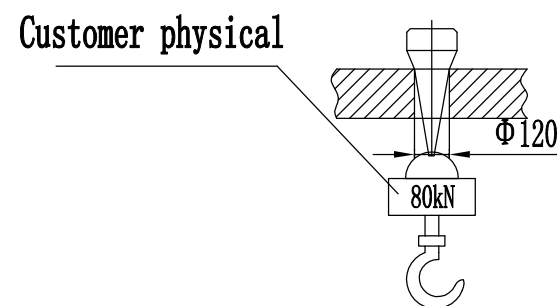
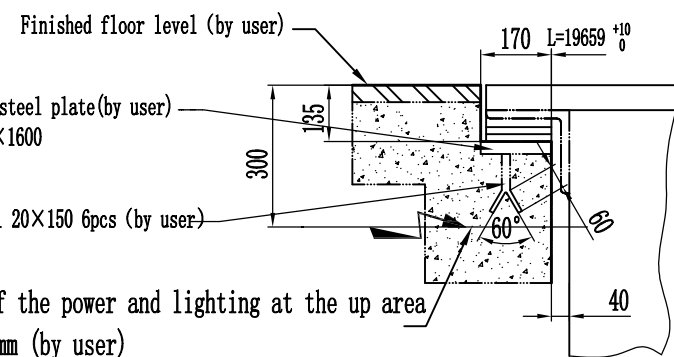

Customer physical

Supply the wire of the power and lighting at the up area
The wire is 5x10mm (by user)

Specification parameter		
Type	DSE-S	
Speed(m/s)	0.5m/s	
Ri se	H = 3000 mm	
Angle	10°	
Supporting R1 (kN)	48 kN	
Supporting R2 (kN)	43 kN	
Supporting R3 (kN)	100 kN	
power	Power Supply	Three-phase AC 415V 50HZ
	Lighting Supply	Single-phase AC 240V 50HZ
Item name		
 AUSTAND Elevator		

Approving construction based the request of the layoutdrawing	
sealed by buyer	
signed by buyer	
Date	
contract number	
Designed by	Eva
Auditing by	Tony